

INSTRUCTIONS

Thank you for choosing Phanteks. This manual will guide you through the installation process of the Evolv Shift XT Hi-Res Display. If you have any questions, please contact us through our customer service or social media.

This manual is for the following models:

PH-ES121XT_LCD Evolv Shift XT Hi-Res Display

Phanteks will not take responsibility for any damages incurred due to incorrect installation or usage of this product.

INCLUDED ACCESSORIES

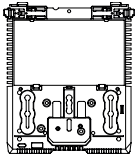

HI-RES DISPLAY
1x



HDMI CABLE
pre-connected

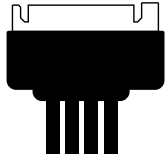

SATA CABLE
pre-connected



POWER SWITCH CABLE
pre-connected

REMOVE EXTERNAL PANELS

All external panels must be removed to install the Evolv Shift XT Hi-Res Display.

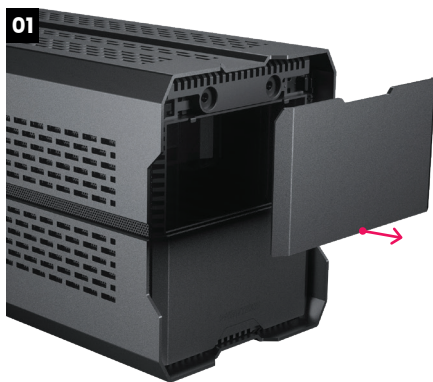

Remove the magnetic aluminum front panel.



Slide the locks inwards to unlock.



Slide the top panel to the front (1) and lift the top panel up with two hands (2).

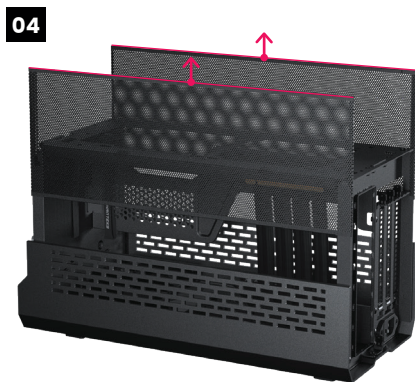

Slide the mesh panels up to remove them.

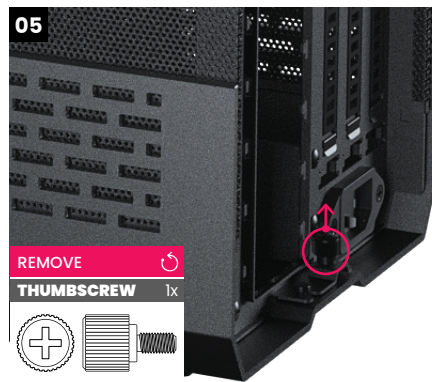

Remove the thumb screw at the rear.



Slide the chassis to the front (1) and lift it from the bottom panel (2).

REMOVE ORIGINAL FRONT PANEL

01

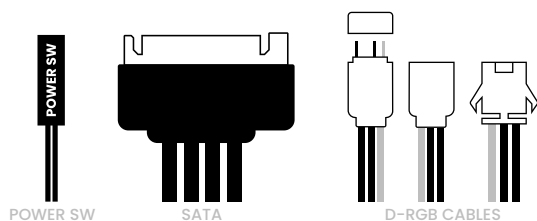

Disconnect these front IO cables.

02

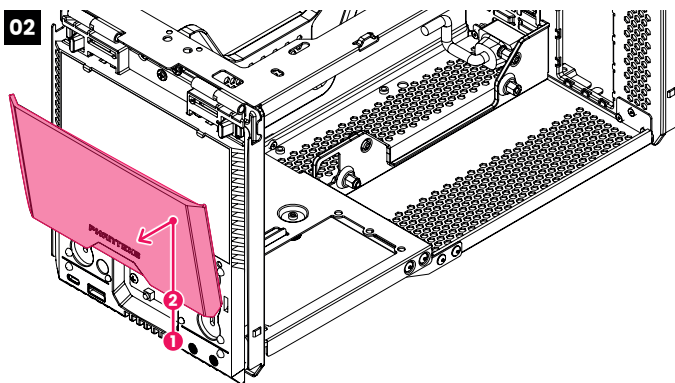

Slide the front aluminum panel upwards (1), slide it further up with some force (2). Remove the panel.

03

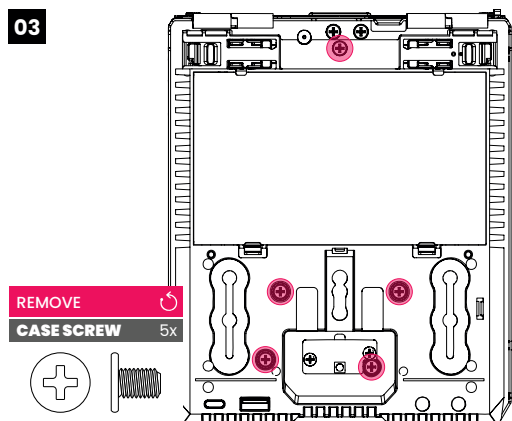

Remove all highlighted screws. Save them for installing the Hi-Res Display.

04

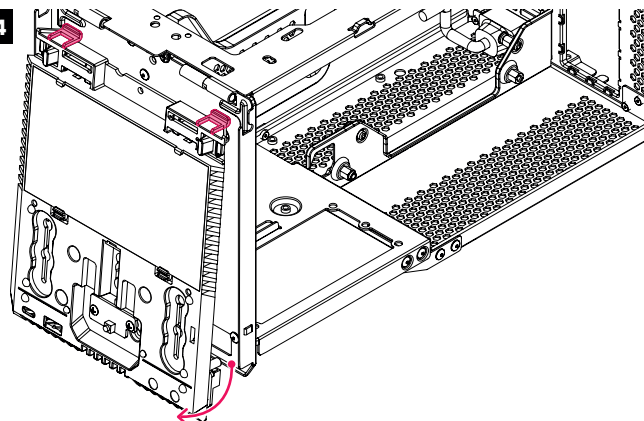

Lift the panel from the bottom out of the chassis. Carefully remove the front IO cables out of the chassis.

INSTALL THE HI-RES DISPLAY PANEL

The Hi-Res Display can now be installed. If a system has already been installed into the chassis, it can remain installed.

01

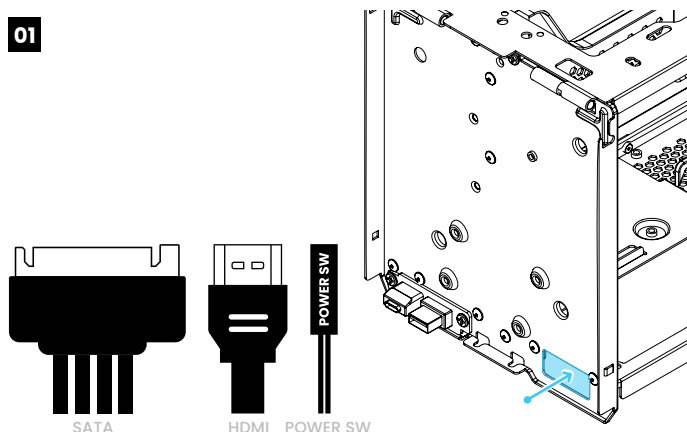

Feed the cables through the designated chassis cut-out.

02

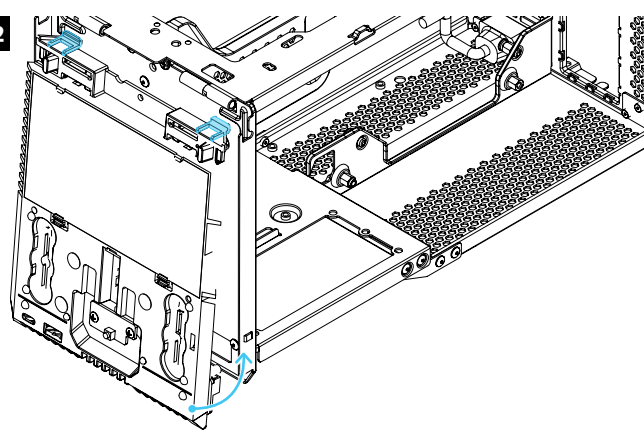

Place the Hi-Res Display panel into the chassis. Make sure it is aligned and seated properly.

03

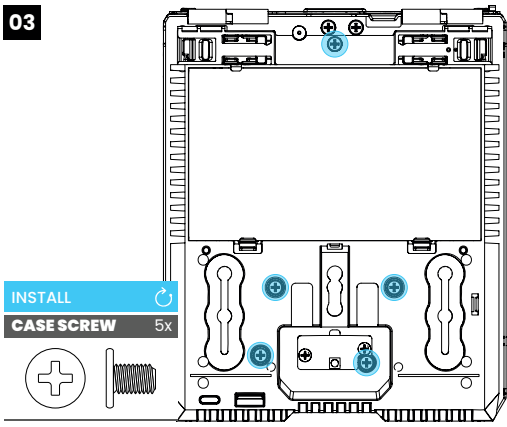

Secure the Hi-Res Display with the original 5 screws.

04

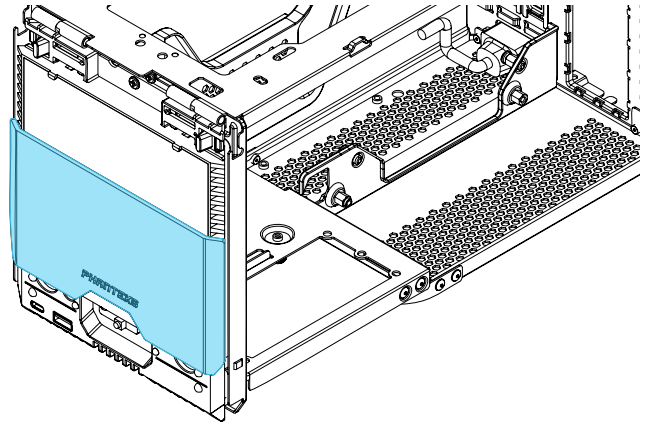

Place the front aluminum panel back and slide is down.

CONNECT THE HI-RES DISPLAY PANEL

01

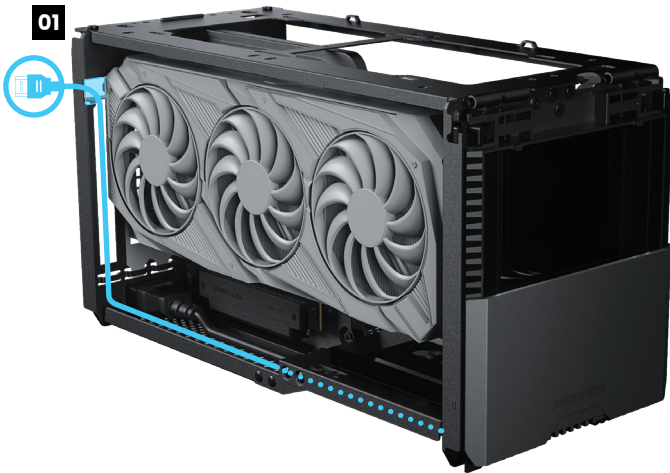

We recommend to route the **HDMI cable** along the bottom of the graphics card. The HDMI cable can then be routed out the rear of the chassis through the PCI thumb screw cut-out.

02

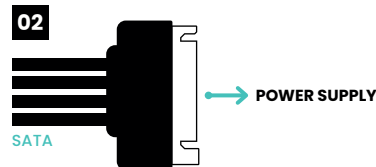

Connect the SATA cable to the power supply.

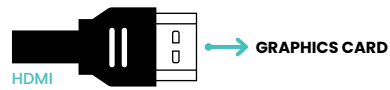

Connect the HDMI to the graphic card.

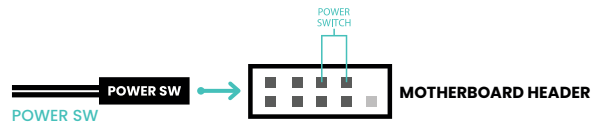

Connect the POWER Switch cable to the motherboard.

REINSTALL ALL EXTERNAL PANELS

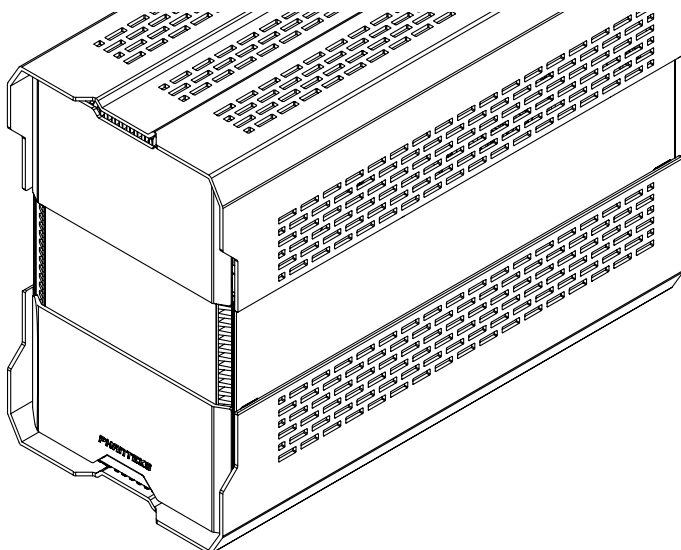

Re-install all external panels.

01

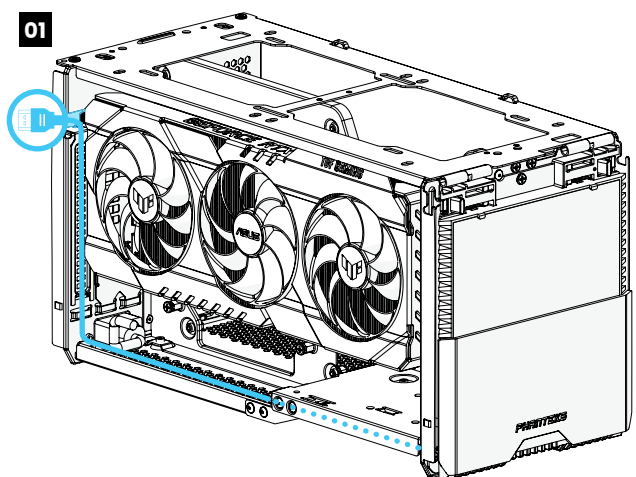

WINDOWS DISPLAY SETTINGS

Follow these steps to setup the Hi-Res Display correctly and further optimize its usability.

SET THE ORIENTATION

- 01 Go to: **START > SETTINGS > SYSTEM > DISPLAY**
- 02 Set the **Display Orientation** to 'Landscape'.

SET THE RESOLUTION

- 01 Go to: **START > SETTINGS > SYSTEM > DISPLAY**
- 02 Set the **Display Resolution** to its native 2560 x 1440 pixels.

OPTIONAL | SET THE SCREEN TO EXTEND

- 01 Go to: **START > SETTINGS > SYSTEM > DISPLAY**
- 02 Set the **second display** to 'Extend'.

OPTIONAL | INCREASE THE SCALING

- 01 Go to: **START > SETTINGS > SYSTEM > DISPLAY**
- 02 Set the **Scaling** to 200%.

OPTIONAL | HIDE THE TASKBAR ON SECOND SCREEN

- 01 Go to: **START > SETTINGS > PERSONALISATION > TASKBAR**
- 02 Turn "OFF" **Show Taskbar On All Displays**, this shows only the taskbar on Display 1.

OPTIONAL | PREVENT CURSOR FROM MOVING TO SECOND SCREEN

- 01 Go to: **START > SETTINGS > SYSTEM > DISPLAY**
- 02 Position the **Hi-Res Display** diagonally of the main display. The cursor can not move to the Hi-Res Display easily (but not impossible).

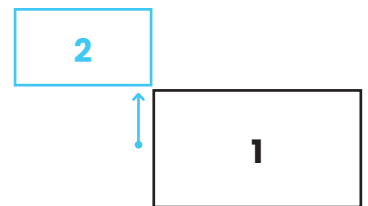

CUSTOMER SERVICE

For any questions or feedback, please contact us through e-mail or social media.

US & Canada
support@phanteksusa.com

International
support@phanteks.com

FOLLOW US
SOCIAL MEDIA

